



CATALOGUE

CÔNG TY TNHH THANG MÁY NAM TRUNG

GIỚI THIỆU CHUNG

CÔNG TY TNHH THANG MÁY NAM TRUNG là nhà cung cấp lắp đặt thang Máy uy tín hàng đầu Việt Nam. Với phương châm “AN TOÀN VÀ TIỆN NGHI” chúng tôi hiểu rằng, mọi nỗ lực về chất lượng và phục vụ của chúng tôi sẽ luôn góp phần vào những thành công trong tương lai của Quý khách hàng.

Dựa trên tiềm lực hiện có về cơ sở vật chất và con người, **NAM TRUNG** tin rằng sẽ mang đến cho Quý khách hàng những giải pháp về căn nhà hiện đại, tiện nghi với: SẢN PHẨM TỐT NHẤT - DỊCH VỤ TỐT NHẤT - CHI PHÍ HỢP LÝ NHẤT đáp ứng tối đa nhu cầu và lợi ích của Quý khách hàng.



NGHIÊN CỨU CÁC CÔNG NGHỆ VÀ THIẾT BỊ THANG MÁY CÙNG CÁC TIÊU CHUẨN

Không ngừng nghiên cứu, đổi mới công nghệ mang đến các sản phẩm đa dạng, đáp ứng ngày càng tốt nhất nhu cầu của thị trường.

KHẢO SÁT XÂY DỰNG VÀ THIẾT KẾ BẢN VẼ KỸ THUẬT

Khảo sát trực tiếp công trình
Tư vấn xây dựng giếng thang theo đúng kích thước thực tế
Thiết kế bản vẽ.



LẮP ĐẶT VẬN HÀNH

Xây dựng đội ngũ kỹ thuật chuyên nghiệp, có năng lực để đảm bảo cung cấp giải pháp lắp đặt vận hành đúng chất lượng.

CĂN CHỈNH HOÀN THIỆN

Toàn bộ thiết bị sẽ được căn chỉnh hoàn thiện, kiểm định đảm bảo vận hành tốt nhất trước khi bàn giao đến khách hàng.



DỊCH VỤ BẢO HÀNH

Nhanh chóng đánh giá hiện trạng, thay thế các thiết bị cần bảo hành nhanh chóng để đem đến dịch vụ tốt cho khách hàng.

Hotline : 0902.774.508 - 0961854879



NTE - CB001

- | | |
|------------|-------------------------------|
| Vách cabin | Inox sọc nhuyễn |
| Cửa cabin | Inox gương |
| Trần cabin | Inox sọc nhuyễn và Inox gương |
| Sàn | Đá granit |



NTE - CB002



NTE - CB003



NTE - CB004



NTE - CB005



NTE - CB006



NTE - CB007



NTE - CB008



NTE - CB009



NTE - CB010



NTE - CB011



NTE - CB012



NTE - CB013

Hotline : 0902.774.508 - 0961854879



NTE - CB014



NTE - CB015

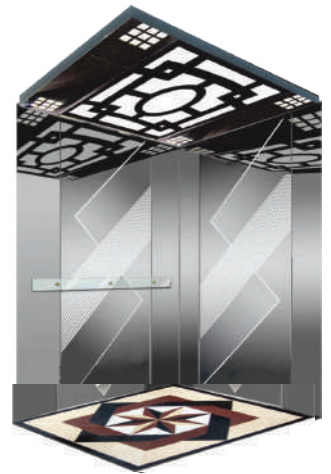

NTE - CB016



NTE - CB017

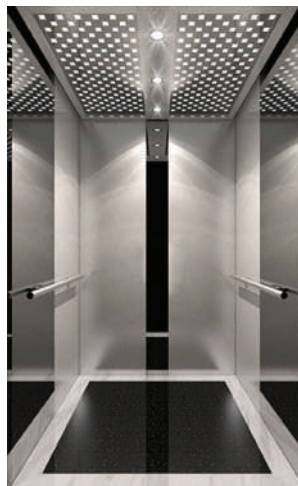

NTE - CB018



NTE - CB019

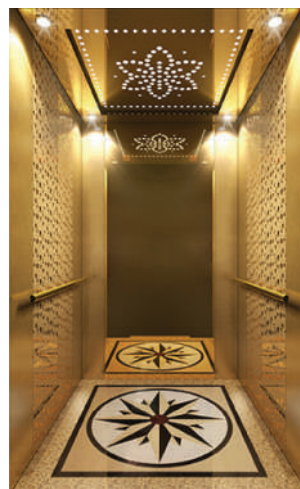

NTE - CB020



NTE - CB021



NTE - CB022

Hotline : 0902.774.508 - 0961854879



- Khung cửa bản hẹp:
- Inox sọc nhuyền 304
 - Mở trung tâm 2 cánh



Cửa tầng khung bản rộng
không tấm trần



Cửa tầng khung bản rộng
có tấm trần

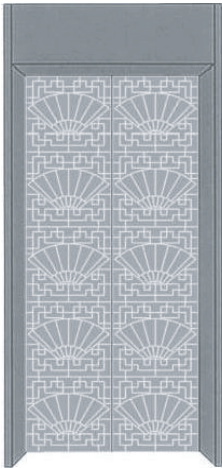

NTE - CT001

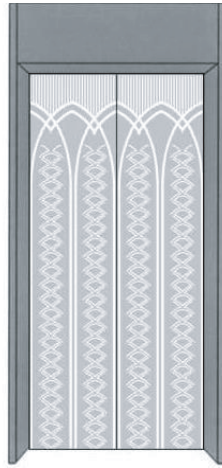

NTE - CB002

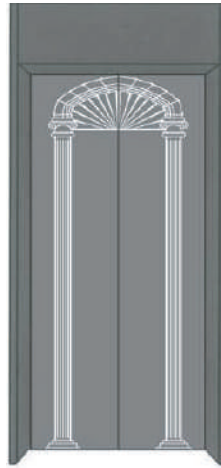

NTE - CB003



NTE - CB004

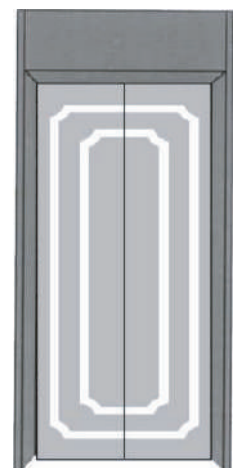

NTE - CB005



NTE - CB006



NTE - CB007



NTE - CB008



NTE - CB009



NTE - CB010

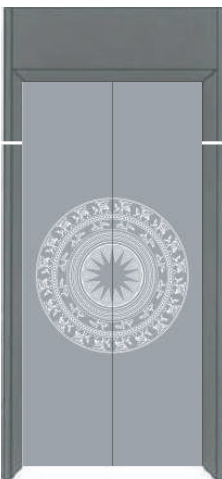

NTE - CB011



NTE - CB012

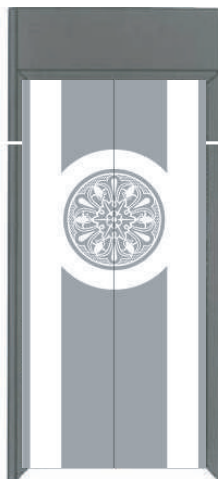

NTE - CB013

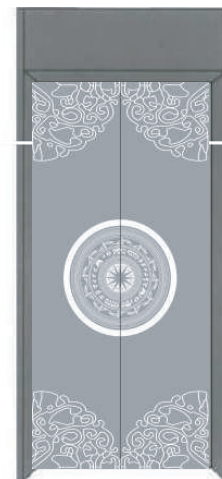

NTE - CB014

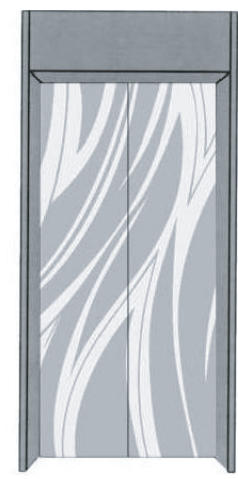

NTE - CB015

Hotline : 0902.774.508 - 0961854879



NTE - CT016



NTE - CT017



NTE - CT018

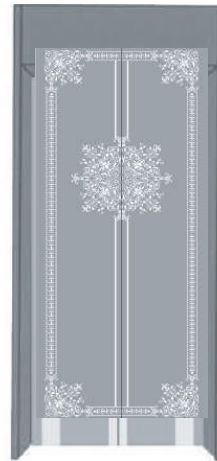

NTE - CT019

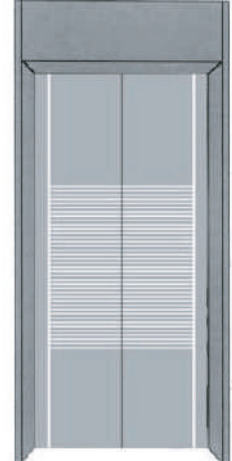

NTE - CT020



NTE - CT021

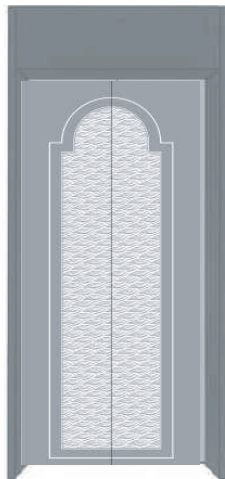

NTE - CT022



NTE - CT023



NTE - CT024



NTE - CT025



NTE - CT026



NTE - CT027



NTE - CT028

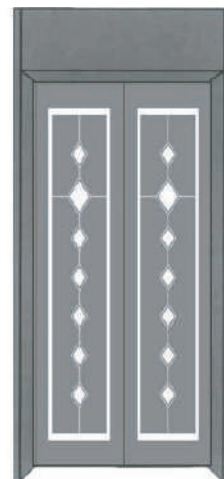

NTE - CT029

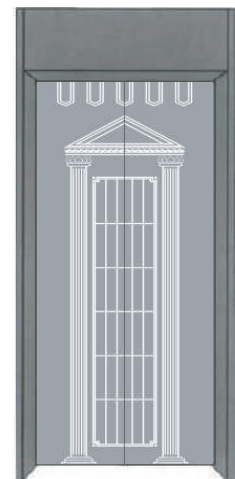

NTE - CT030

Hotline : 0902.774.508 - 0961854879

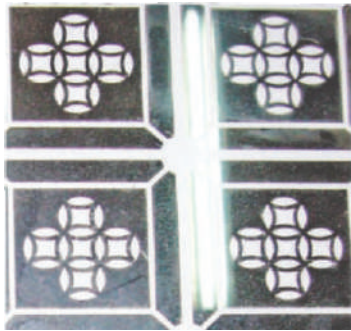

NTE - HV001

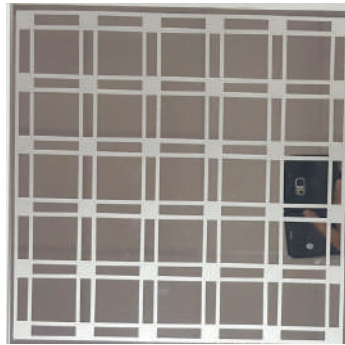

NTE - HV002

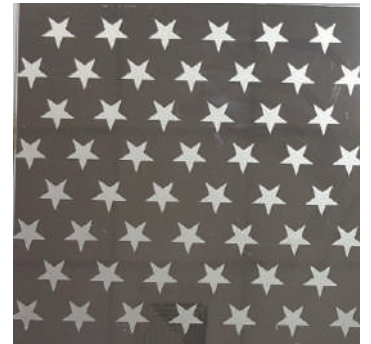

NTE - HV003

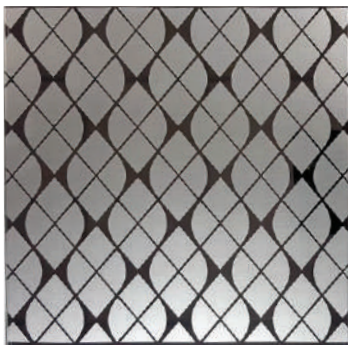

NTE - HV004



NTE - HV005

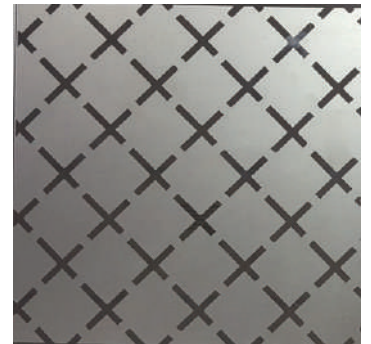

NTE - HV006

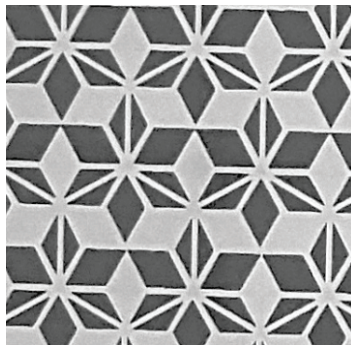

NTE - HV007



NTE - HV008



NTE - HV009

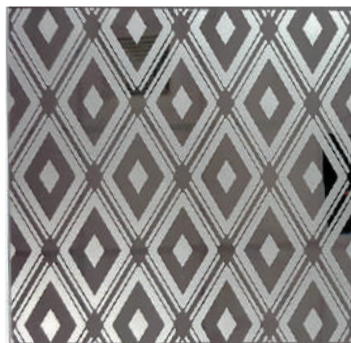

NTE - HV010



NTE - HV011

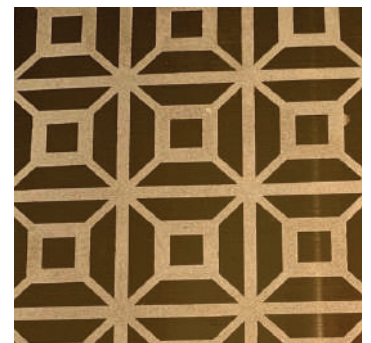

NTE - HV012

Hotline : 0902.774.508 - 0961854879



NTE - SD 01



NTE - SD 02



NTE - SD 03



NTE - SD 04



NTE - SD 05

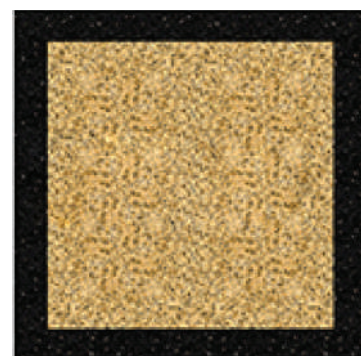

NTE - SD 06



NTE - SD 07



NTE - SD 08

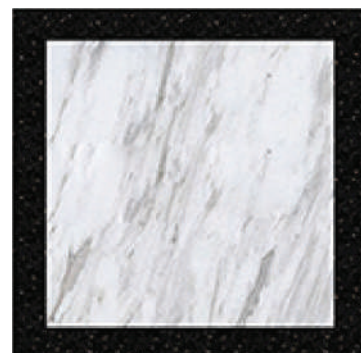

NTE - SD 09

Hotline : 0902.774.508 - 0961854879

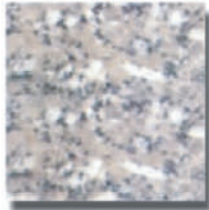

NTE - SĐ 10



NTE - SĐ 11

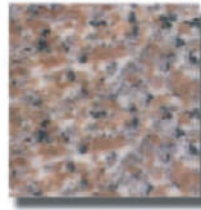

NTE - SĐ 12



NTE - SĐ 13

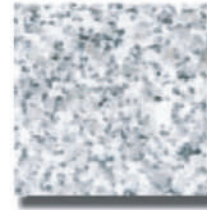

NTE - SĐ 14



NTE - SĐ 15



NTE - SĐ 16



NTE - SĐ 17



NTE - SĐ 18



NTE - SĐ 19



NTE - SĐ 20

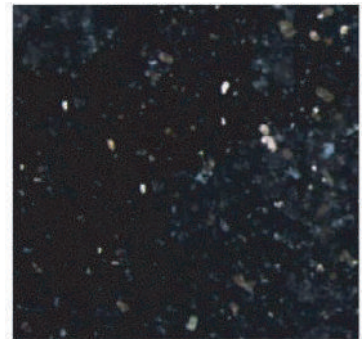

NTE - SĐ 21



NTE - SĐ 22



NTE - SĐ 23

Hotline : 0902.774.508 - 0961854879



NTE - TG001



NTE - TG002



NTE - TG003



NTE - TG004



NTE - TG005



NTE - TG006



NTE - TG007



NTE - TG008



NTE - TG009



NTE - TG010



NTE - TG011



NTE - TG012

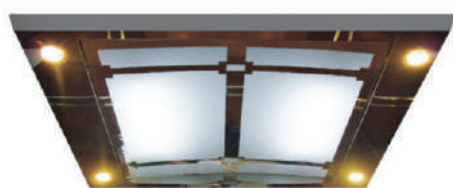

NTE - TG013



NTE - TG014

Hotline : 0902.774.508 - 0961854879



NTE - TG015



NTE - TG016

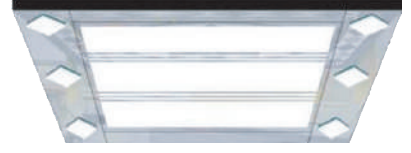

NTE - TG017



NTE - TG018



NTE - TG019



NTE - TG020



NTE - TG021

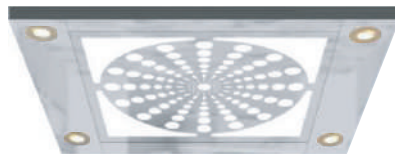

NTE - TG022



NTE - TG023



NTE - TG024



NTE - TG025



NTE - TG026



NTE - TG027

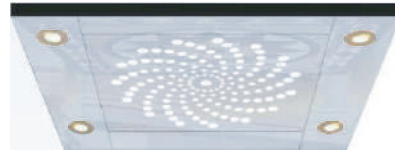

NTE - TG028

Hotline : 0902.774.508 - 0961854879



Mitsubishi FYJ-140



Montanari - M75S



Montanari - MG25S



Montanari - MGX75



Montanari - MGX80



OSAWA



Ziehl-Abegg



Fuji FK-100



Fuji FK-200

Hotline : 0902.774.508 - 0961854879



TỦ ĐIỆN FUJI MT 70-KOREA



**- PLC: MITSUBISHI - JAPAN
- VVVF: YASKAWA - JAPAN**



TỦ ĐIỆN NGOẠI NHẬP NIPPON



TỦ ĐIỆN NGOẠI NHẬP STEP

Hotline : 0902.774.508 - 0961854879



NIPPON MALAYSIA NICE 3000



STEP ELECTRIC THƯỢNG HẢI



.....



TỦ ĐIỆN STEP THAILAND



.....



Tủ điện OSAWA

Hotline : 0902.774.508 - 0961854879

Hotline : 0902.774.508 - 0961854879



NTE - BT01



NTE - BT02



NTE - BT03



NTE - BT04



NTE - BT05



NTE - BT06

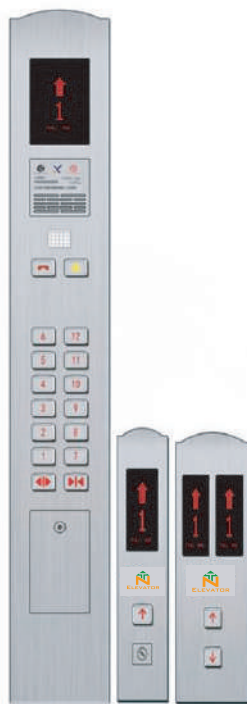

NTE - BT07

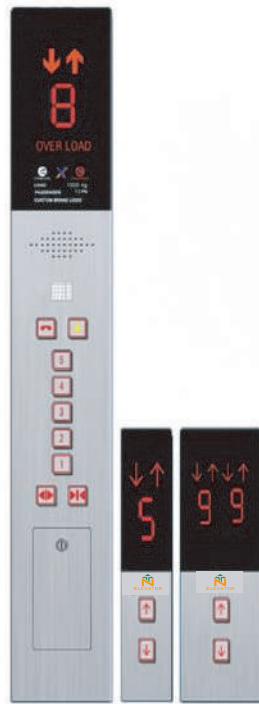

NTE - BT08



NTE - BT09



NTE - BT10



NTE - BT11



NTE - BT12



NTE - BT13



NTE - BT14



NTE - BT15



NTE - BT16



NTE - BT17



NTE - BT18



NTE - BT19



NTE - BT20



NTE - BT21



NTE - BT22



NTE - BT23



NTE - BT24

Hotline : 0902.774.508 - 0961854879



Hotline : 0902.774.508 - 0961854879



NTE - TV 001



NTE - TV 002



NTE - TV 003



NTE - TV 004



NTE - TV 005



NTE - TV 006



NTE - TV 007



NTE - TV 008



NTE - NT01



NTE - NT02



NTE - NT03



NTE - NT04



NTE - NT05



NTE - NT06



NTE - NT07



NTE - NT08



NTE - NT09



NTE - NT10



NTE - NT11



NTE - NT12

Hotline : 0902.774.508 - 0961854879

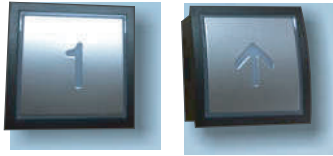

VUÔNG TQ



LA 3024



3929



VUÔNG BT3328S



PB 31



BQ



MAN100



BA 530

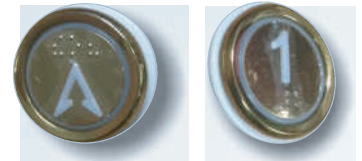

BA 531



OVAL EMR100



OVAL TWS



EB 111



35CA-B



35CCO



EBR001



EB 410

Hotline : 0902.774.508 - 0961.854879

THANG TẢI HÀNG



- Thang tải hàng tải trọng từ 1000-5000kg.
- Dừng cửa mở tay, cửa cuốn, cửa tự động.
- Vách cabin bằng inox sọc nhuyền, thép phun sơn tĩnh điện, kèm thanh chống va đập

THANG TẢI THỰC PHẨM

- Thang máy tải thực phẩm phù hợp cho việc vận chuyển đồ dùng của nhà bếp, các loại thức ăn trong nhà hàng, khách sạn, những vận dụng hàng hóa đơn giản trong siêu thị, thư viện,...
- Sản xuất theo nhu cầu của khách hàng về tải trọng, kích thước, tốc độ



THANG TẢI Ô TÔ

- Cung cấp thang tải ô tô tải trọng 2000/2500/3000kg phục vụ trong các tòa nhà cao ốc, văn phòng, chung cư có thiết kế bãi đỗ xe.





NTE - QS01



NTE - QS02



NTE - QS03

Hotline : 0902.774.508 - 0961.854879

BẢNG TIÊU CHUẨN KỸ THUẬT THANG LỒNG KÍNH CÓ PHÒNG MÁY

MÃ HIỆU	TẢI TRỌNG	NGƯỜI	TỐC ĐỘ	KÍCH THƯỚC (mm)			
				Cửa mở JJ x HH	Cabin AA x BB	Hố thang AH x BH	OH/Pit
P8	600	8	60	700x2100	1200x1200	1650x1600	4200/1500
			90				4400/1600
P10	750	10	60	800x2100	1400x1350	1850x2000	4200/1500
			90				4400/1600
P15	1000	15	60	800x2100	1400x1500	1850x2100	4200/1500
			90				4400/1600

BẢNG TIÊU CHUẨN KỸ THUẬT THANG LỒNG KÍNH KHÔNG PHÒNG MÁY

MÃ HIỆU	TẢI TRỌNG	NGƯỜI	TỐC ĐỘ	KÍCH THƯỚC (mm)			
				Cửa mở JJ x HH	Cabin AA x BB	Hố thang AH x BH	OH/Pit
P8	600	8	60	700x2100	1200x1200	2000x1800	4600/1500
			90				4800/1600
P10	750	10	60	800x2100	1400x1350	2200x2000	4600/1500
			90				4800/1600
P15	1000	15	60	800x2100	1400x1500	2200x2100	4600/1500
			90				4800/1600



NTE - QS04



NTE - QS05



NTE - QS06

BẢNG TIÊU CHUẨN KỸ THUẬT THANG LỒNG KÍNH CÓ PHÒNG MÁY

MÃ HIỆU	TẢI TRỌNG Kg	NGƯỜI	TỐC ĐỘ m/phút	KÍCH THƯỚC (mm)			
				Cửa mở JJ x HH	Cabin AA x BB	Hố thang AH x BH	OH/Pit
P8	600	8	60	700x2100	1200x1200	1650x1600	4200/1500
			90				4400/1600
P10	750	10	60	800x2100	1400x1350	1850x2000	4200/1500
			90				4400/1600
P15	1000	15	60	800x2100	1400x1500	1850x2100	4200/1500
			90				4400/1600

BẢNG TIÊU CHUẨN KỸ THUẬT THANG LỒNG KÍNH KHÔNG PHÒNG MÁY

MÃ HIỆU	TẢI TRỌNG Kg	NGƯỜI	TỐC ĐỘ m/phút	KÍCH THƯỚC (mm)			
				Cửa mở JJ x HH	Cabin AA x BB	Hố thang AH x BH	OH/Pit
P8	600	8	60	700x2100	1200x1200	2000x1800	4600/1500
			90				4800/1600
P10	750	10	60	800x2100	1400x1350	2200x2000	4600/1500
			90				4800/1600
P15	1000	15	60	800x2100	1400x1500	2200x2100	4600/1500
			90				4800/1600

Hotline : 0902.774.508 - 0961854879



NTE - BV01



NTE - BV02

Hotline : 0902.774.508 - 0961854879

BẢNG TIÊU CHUẨN KỸ THUẬT THANG TẢI GIƯỜNG BỆNH CÓ PHÒNG MÁY

MÃ HIỆU	TẢI TRỌNG Kg	TỐC ĐỘ m/phút	KÍCH THƯỚC (mm)			
			Cửa mở JJ x HH	Cabin AA x BB	Hố thang AH x BH	OH/Pit
B1000	1000	60	1000x2100	1100x2100	1900x2550	4200/1400
		90				4400/1500
B1350	1350	60	1100x2100	1300x2300	2100x2800	4200/1400
		90				4400/1500
B1500	1500	60	1200x2100	1400x2300	2200x1500	4200/1400
		90				4400/1500

BẢNG TIÊU CHUẨN KỸ THUẬT THANG TẢI GIƯỜNG BỆNH KHÔNG PHÒNG MÁY

MÃ HIỆU	TẢI TRỌNG Kg	TỐC ĐỘ m/phút	KÍCH THƯỚC (mm)			
			Cửa mở JJ x HH	Cabin AA x BB	Hố thang AH x BH	OH/Pit
B1000	1000	60	1000x2100	1100x2100	2000x2550	4200/1400
		90				4400/1500
B1350	1350	60	1100x2100	1300x2300	2200x2800	4200/1500
		90				4400/1500
B1500	1500	60	1200x2300	1400x2300	2300x2800	4200/1500
		90				4400/1500

HỆ THỐNG THANG TẢI KHÁCH (CỐ PHÒNG MÁY)

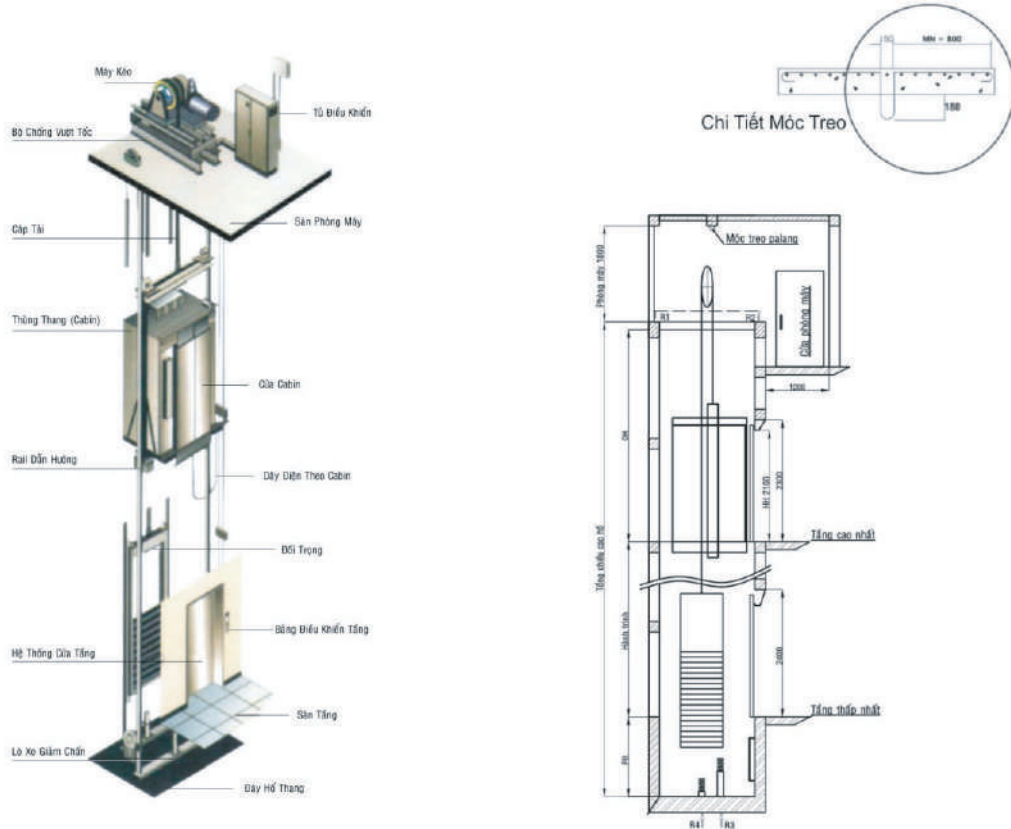

Hotline : 0902.774.508 - 0961854879

ĐỐI TRỌNG ĐẶT PHÍA SAU

MÃ HIỆU	TẢI TRỌNG Kg	NGƯỜI	TỐC ĐỘ m/phút	KÍCH THƯỚC (mm)			
				Cửa mở JJ	Cabin AA x BB	Hố thang AH x BH	OH/Pit
P4	300	4	60	700	1100x900	1500x1500	4000/1400
			90		1100x1000	1500x1600	4200/1500
P6	450	6	60	700	1200x1000	1600x1600	4000/1400
				750	1300x1000	1700x1600	
			90	800	1400x900	1800x1500	4200/1500
P8	600	8	60	800	1400x1100	1800x1700	4200/1500
			90	850	1400x1200	1800x1800	4500/1600
				900	1400x1300	1900x1900	
P10	750	10	60	800	1400x1100	1800x1700	4200/1500
			90	850	1400x1200	1800x1800	4500/1600
				900	1400x1350	1900x2000	
P15	1000	15	60	900	1600x1500	2000x2100	4200/1500
			90	950	1700x1600	2100x2200	4500/1600
				1000	1800x1700	2200x2400	

HỆ THỐNG THANG TẢI KHÁCH (KHÔNG PHÒNG MÁY)

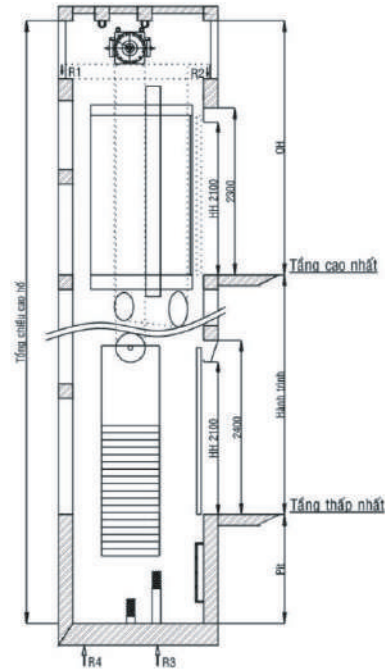
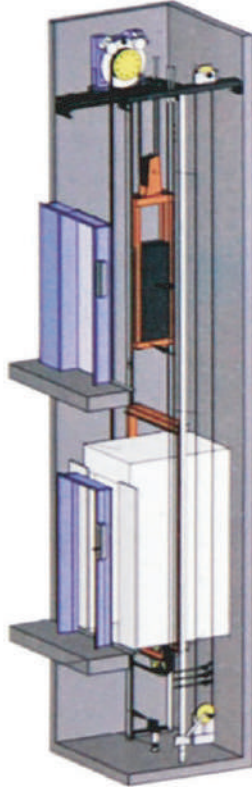

Hotline : 0902.774.508 - 0961854879

ĐỐI TRỌNG ĐẶT PHÍA SAU

MÃ HIỆU	TẢI TRỌNG Kg	NGƯỜI	TỐC ĐỘ m/phút	KÍCH THƯỚC (mm)			
				Cửa mở JJ	Cabin AA x BB	Hố thang AH x BH	OH/Pit
P4	300	4	60	700	1100x900	1500x1500	3800/1400
			90		1100x1000	1500x1600	3900/1500
P6	450	6	60	700	1200x1000	1600x1600	3800/1400
			90	750	1300x1000	1700x1600	
				800	1400x900	1800x1500	3900/1500
P8	600	8	60	800	1400x1100	1800x1700	
			90	850	1400x1200	1800x1800	4200/1600
				900	1400x1300	1900x1900	
P10	750	10	60	800	1400x1100	1800x1700	4000/1500
			90	850	1400x1200	1800x1800	4200/1600
				900	1400x1350	1900x2000	
P15	1000	15	60	900	1600x1500	2000x2100	4200/1500
			90	950	1700x1600	2100x2200	4400/1600
				1000	1800x1700	2200x2400	



SERVICE

Bảo hành và bảo trì

Đưa chất lượng bảo trì lên mức cao nhất bằng những chuyên viên kỹ thuật nhiều năm kinh nghiệm đảm nhận nhằm đảm bảo sự hoạt động liên tục của hệ thống thang máy, thang cuốn. Giảm thiểu thời gian nhưng thang máy luôn phù hợp với tầm cỡ và yêu cầu của quý khách. Cung cấp dịch vụ trực sửa chữa tại công trình 24/24 khi quý khách có nhu cầu.

- Cung cấp dịch vụ sửa chữa khi các thiết bị dừng hoạt động hay hư hỏng bất thường
- Bảo trì để phòng ngừa hư hỏng định kỳ 01 lần/tháng
- Thực hiện các công việc duy trì hoạt động cho các thiết bị của thang máy
- Tư vấn để đổi mới kỹ thuật mỹ thuật
- Kiểm tra kỹ thuật định kỳ
- Hướng dẫn và tư vấn sử dụng cho khách hàng
- Bảo trì để sửa chữa các hư hỏng
- Sửa chữa các hư hỏng, sự cố
- Giải quyết những phàn nàn của khách hàng về các hư hỏng của thang máy
- Bảo trì theo yêu cầu khách hàng

Hotline : 0902.774.508 - 0961854879



CÔNG TY TNHH THANG MÁY NAM TRUNG

NAM TRUNG ELEVATOR CO., LTD

Địa chỉ: Số 58/18 Đường Hà Huy Giáp, P. Thạnh Lộc, Q. 12, TP. Hồ Chí Minh

Văn phòng đại diện: 201 Duy Tân, P. Diên Hồng, TP. Pleiku, Tỉnh Gia Lai

Điện thoại: 0902.774.508 * 0961.854.879

Email: namtrungelevator2020@gmail.com

Mã số thuế: 0316306516

Đại diện: (Ông) Đặng Quốc Nam